

Smart Wi-Fi Touch Light Switch

Quick Start Guide

Supports 1-Gang to 4-Gang models
Smart. Simple. Secure



View Full Manual

Support & Safety

Assembled in Australia



2-Year
Australian
Warranty



Download the App



SMART LIFE



TUYA SMART



MOES APP

Safety note: Installation must be completed by a licensed electrician.



support@ozntec.com.au



www.ozntec.com.au



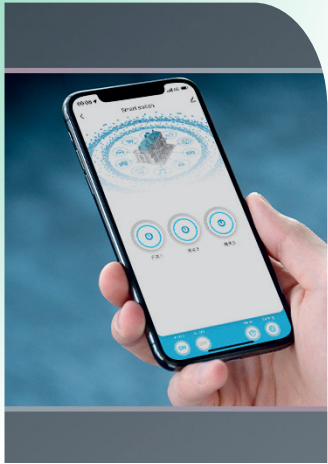

"What's in the Box"

-  Smart Switch
-  Capacitor
-  Glass Faceplate
-  Mounting Screws





App Setup Instructions

-  Compatible apps: Smart Life, Tuya Smart, MOES App
-  QR codes for app download (iOS & Android)
-  Pairing steps: Install app, create account, add device, select "Wall Switch (Wi-Fi)", connect to 2.4GHz Wi-Fi, follow prompts





Voice Control

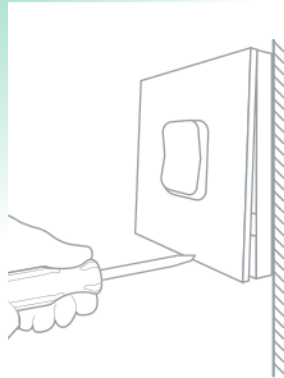

-  Works with: Amazon Alexa, Google Home
-  Sample commands: "Alexa, turn on the kitchen lights", "Hey Google, switch off the bedroom light"



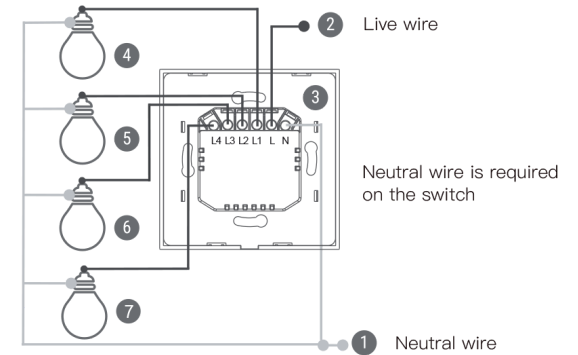
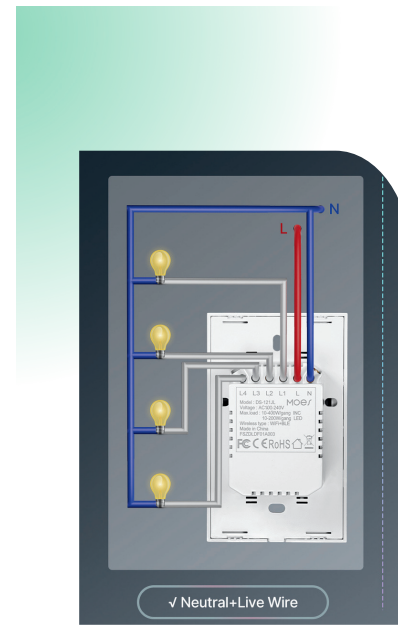

Installation Steps

-  Turn off power at the mains
-  Remove the existing switch
-  Connect wires to terminals
-  Install capacitor if required
-  Mount the switch and restore power



Wiring Diagram

-  Clear, simplified wiring diagram for 1-Gang (others optional)
-  Labelled connections: L (Live), N (Neutral), L1, L2, etc.
-  Capacitor installation shown for no-neutral setups